

Pacific Northwest
Chapter



NEWSLETTER

FEBRUARY 1991

MEETING REPORT

Seventeen members and guests met on January 13th in Vancouver, Washington. During the meeting we had four new members join: Robert McGown, Kris Dennis, Jay & Trish Aldrich, all of Portland. During the business meeting, minutes (as published) were approved and Cheryl Stewart presented the financial report. A number of action items were approved by the members. These were:

1. The theme for the Pacific Northwest Chapter 17th Annual Mineral Symposium will be TOURMALINE as nominated by Arlene Handley and seconded by Lita Smith-Gharet. It will be held in the Sherwood Inn in South Tacoma next to I-5.
2. The budget for the Washington State special Rocks and Minerals issue has been exceeded. The treasurer was authorized to reimburse costs incurred by Mike Groben and Rick Dillhoff.
3. Dues have stayed the same for more than ten years. Costs for mailing, supplies, and telephone have escalated over time. The members present voted to increase the dues to \$15.00 per year effective for the current 1991 year. It should be pointed out that of the above amount, we have to send \$3.00 to National Friends of Mineralogy.
4. The dates for the collecting/clean-up field trip will be August 16-18th; we are again thinking of the Washington Pass area (Golden Horn batholith). However, any other suggestions are welcome.

Then followed a discussion of this year's symposium. We will check into obtaining a insurance rider with the Sherwood Inn. Mike Groben will look into obtaing speakers, dealers(4), and later coordinate a list of displays. Cheryl Stewart is storing the FM cases and will negotiate a final agreement with the Sherwood Inn. Ray Lasmanis will look after the logistics of moving our cases and renting additional ones from the Tacoma Agate Club. Lita Smith-Gharet will obtain plaques and T-shirts. Other appointments are to follow.

In terms of other business, Ray Lasmanis reported that he has been approached with a preliminary proposal for the chapter to acquire a noted mineral locality. The membership instructed Ray to fully develop the proposal and report back to the members for consideration at the next meeting.

It was suggested that during our meetings we have a program with the hopes of attracting more members to attend. Carl Harris agreed to be meeting program chairman.

Raymond Lasmanis
FM Secretary

TREASURER'S REPORT 1/13/91

Beginning balance		\$504.91
Deposits		
Dues & minerals	\$61.00	
2nd half int.	<u>18.51</u>	
		+79.51
Expenditures		
Service charge	5.00	
Postage	108.10	
Phone	39.81	
NW Micromounters	<u>10.00</u>	
		-162.91
Ending Balance.....		\$421.51

Cheryl Stewart
FM Treasurer

MEETING NOTICE

The next meeting of the chapter will be Saturday, April 27th at 10:30 am in the offices of the Division of Geology and Earth Resources in Lacey, WA. The program will include a video tape of the volcanoes of the Hawaiian islands. Also, a tour of the laboratory at the division's office will take place with emphasis on principles of X-ray diffraction in mineral identification.



CORRESPONDENCE

We have received a very nice letter from Ardis Bynum of the US Forest Service (copy attached). President Becky Harris will appoint a committee to help with the Early Winters Visitor Center interpretative display. In particular, I am Certain that there will be a need to locate representative mineral specimens.



United States
Department of
Agriculture

Forest
Service

Winthrop Ranger District
P.O. Box 579
Winthrop, WA 98862
509/896-2266

Reply to: 2800/2300

Date: January 24, 1991

Raymond Lasmanis, Secretary
Pacific Northwest Chapter of Friends of Mineralogy
Suite 155
910 Sleater Kinney SE
Lacey, WA 98503

Dear Ray,

Great news. We got funded to build a minerals display cabinet for Early Winters Visitor Center. Based on conversations that I had with various of you last fall, we will be sending you a "drawing" of the proposed display case. I want to wait until the person who manages Early Winters is back on board before we do the drawing. We will be getting back to you soon with a design for your review. We're looking forward to developing a great partnership and a great display of minerals of the Golden Horn Batholith (and more).

Sincerely,

ARDIS BYNUM
Resource Assistant

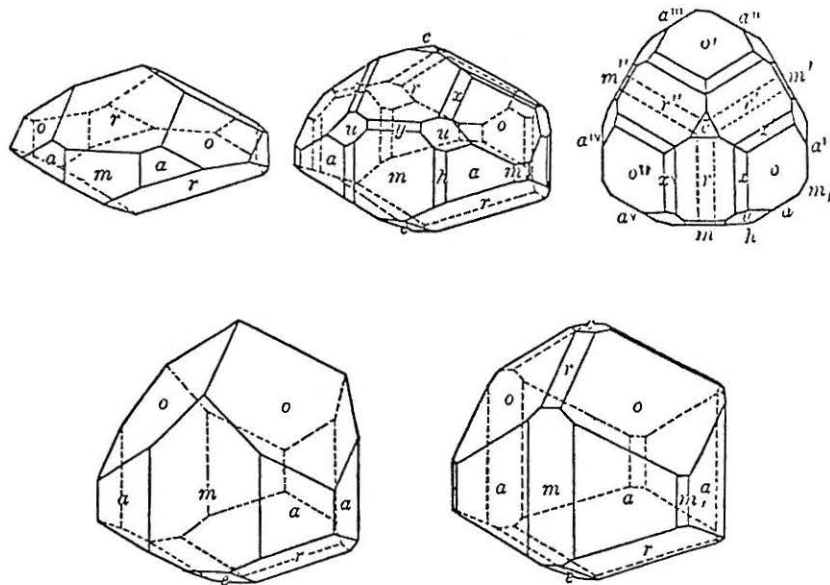

Line drawings of Pierrepont, New York uvite [from Dana, (1892), *The System of Mineralogy*, p. 551].